

Q'STRAIN[®]

QLK[®]

QUANTUM Q6 EDGE HD

MOUNTING BRACKET INSTALLATION INSTRUCTIONS

STOP

READ ALL INSTRUCTIONS PRIOR TO INSTALLATION

- **Some foot rest options will require the user to raise prior to allow docking. Any kerb climbers fitted to the chair may interfere with the docking process – please ensure at least 85mm ground clearance.**
- This is a comprehensive step-by-step instruction guide on how to install the Quantum Q6 Edge HD (Wheelchair manufacture date: 2023).
- Please note, some images may not be the same colour as the supplied equipment.
- Make sure to read, understand and follow these instructions.
- To address any questions, contact the nearest Q'STRAIN[®] office.
- All deviations and alterations from these instructions **MUST** be reported to both your supervisor and Q'STRAIN[®]
- For installation of the QLK Docking system, please refer to the separate Installation Instructions and the Use and Care Manual.



IMPORTANT SAFEGUARDS AND WARNINGS

- All equipment and components **MUST** be installed and serviced by an experienced and trained technician.
- The QLK Wheelchair Docking System complies with all applicable requirements of ADA, FMVSS, CMVSS, SAE J2249, CSA Z604, AS2942, ISO 10542-1 and ANSI/RESNA WC-4 SECTION 18.
- This System is a complete integrated system, do not alter or modify it in any way and do not interchange or substitute any components. Any deviation from these recommendations is the responsibility of the installer.
- The QLK Docking System, bracket and its components **MUST** be regularly inspected, cleaned, and maintained.
- Do **NOT** attempt to repair, adjust, or modify any component(s) of the QLK system or bracket without consulting a Q'STRAIN[®] representative.
- The QLK Wheelchair Docking System should not be operated by anyone who does not have full comprehension of how the System works or if the System is not working properly.
- The QLK Wheelchair Docking System, bracket and all system components including floor and wall anchorages **MUST** be replaced after a vehicle collision.
- The QLK Wheelchair Docking System **MUST** be installed with a compliant occupant restraint system (shoulder and lap belt).
- Broken and worn components **MUST** be replaced.
- All damages and defects **MUST** be reported to both your supervisor and Q'STRAIN[®].
- Only use Q'STRAIN[®] components with this system, including hardware and wheelchair interface bracket unless otherwise stated.
- Q'STRAIN[®] wheelchair brackets and QLK docking station have been designed and tested as a system, for use with specific wheelchairs. Q'STRAIN[®] supply all the components/hardware required to install the system so the configuration is the same as that tested and set out in the individual installation instructions. Occasionally, wheelchairs may have additional components installed which are not detailed in our installation instructions and which may need to be temporarily removed in order to gain access to fixing holes or support frames to enable the attachment of the wheelchair bracket. It is the responsibility of the installer to ensure that all such wheelchair component(s) are put back in their original location using the original fixings or fixing of the same size and grade. Each wheelchair should be test driven after fitment of the bracket, to ensure it is functioning correctly.

SAVE THESE INSTRUCTIONS



	Go To Sequence Number Ir a Número de secuencia	Aller à Numéro de séquence Gehe zu Sequenznummer
	Repeat Sequence(s) in defined order Repita la secuencia en un orden definido	Répéter la séquence dans l'ordre défini Sequenz in definierter Reihenfolge wiederholen
	Refer to sequence # Consulte la secuencia #	Se référer à la séquence # Siehe Sequenz #
	Step Number Número de paso	Numéro d'étape Schrittnummer
	Rotate/Turn (angle) Rotar/Girar (ángulo)	Tourner/Tourner (angle) Drehen/Drehen (Winkel)
	Move circled object Mover objeto dentro de un círculo	Déplacer objet encerclé Bewegen eingekreistes Objekt
	Remove/Detach highlighted object Quitar/Separar objeto resaltado	Supprimer/Détacher l'objet en surbrillance Markiertes Objekt entfernen/lösen
	Move to Remove or Replace Mover para Quitar o Reemplazar	Déplacer pour supprimer ou remplacer Wechseln Sie zu Entfernen oder Ersetzen
	Repeat (sequence) on opposite side Repetir (secuencia) en el lado opuesto	Répéter (séquence) du côté opposé Wiederholen Sie (Sequenz) auf der gegenüberliegenden Seite
	Inspect Inspeccionar	Inspecter Prüfen
	Disconnect Battery Desconecte la batería	Déconnecter la batterie Batterie abklemmen
	Reconnect Battery Vuelva a conectar la batería	Reconnecter la batterie Batterie wieder anschließen
	Remove Battery Retire la batería	Retirer la batterie Batterie entfernen
	Replace Battery Reemplazar la batería	Remplacer la batterie Batterie wechseln
	Allen Key (size) Llave Allen (tamaño)	Clé Allen (taille) Inbusschlüssel (Größe)
	Spanner/Socket (size) Llave/Tubo (tamaño)	Clé/douille (taille) Schraubenschlüssel/Stecknuss (Größe)



	Disconnect Desconectar	Déconnecter Trennen
	Optional Step Paso opcional	Étape facultative Optionaler Schritt
	Medium Strength Threadlock Threadlock de fuerza media	Threadlock de puissance moyenne Threadlock mittlerer Stärke
	Tighten Apretar	Serrer Spannen
	Do Not Tighten No apriete	Ne pas serrer Nicht festziehen
	Measure Medida	Mesure Messen
	Refer to OEM Manual Consulte el Manual del OEM	Reportez-vous au manuel OEM Siehe OEM-Handbuch
	Caution! ¡Precaución!	Mise en garde! Vorsicht!
	Lift/Suspend Levantar/Suspender	Soulever/Suspendre Anheben/Aussetzen
	Discard Desechar	Jeter Verwerfen
	Cut Corte	Couper Schnitt
	Cable Tie Brida	Attache de câble Kabelbinder
	Points Toward Front of Chair Apunta hacia el frente de la silla	Points vers l'avant de la chaise Zeigt zur Vorderseite des Stuhls
	Draw/Mark Dibujar / Nota	Dessiner / Marquer Malen / Marke
	Rotary Tool Herramienta rotativa	Outil rotatif Rotierendes Werkzeug



		
QS01278		1
Q04C1413		1
Q04C1414		1
Q03C0106 8mm		2
Q03C0098 4mm		2
QE9-8142 M6x16mm		8
QE9-8154 M6		2
Q04S151		1
QC03004 (2.5")		1

Q080074

Q04BR145

Q04F0131

QE-9182

INSTALLATION PROCEDURE

Procédure d'installation Procedimiento de instalación Installationsvorgang

1

Some images used in the following procedure may not be a true representation of actual chair

Certaines images utilisées dans la procédure suivante peuvent ne pas être une représentation fidèle de la chaise réelle

Algunas imágenes utilizadas en el siguiente procedimiento pueden no ser una representación fiel de la silla real

Einige Bilder, die im folgenden Verfahren verwendet werden, sind möglicherweise keine wirkliche Darstellung des tatsächlichen Stuhls



2

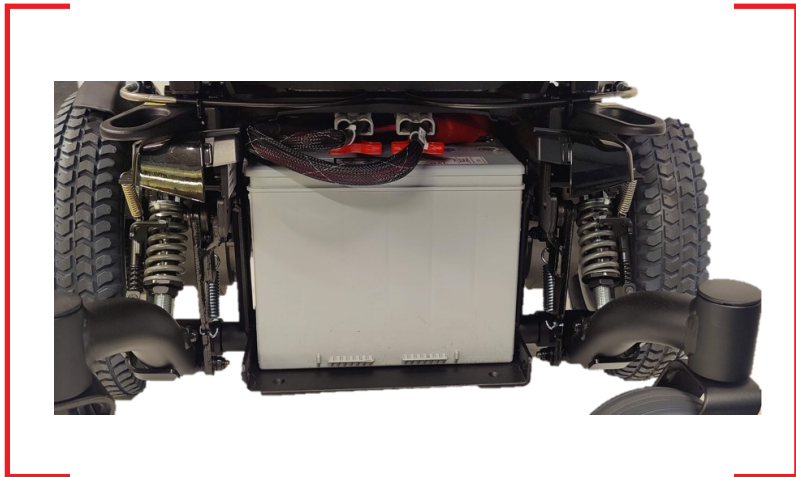
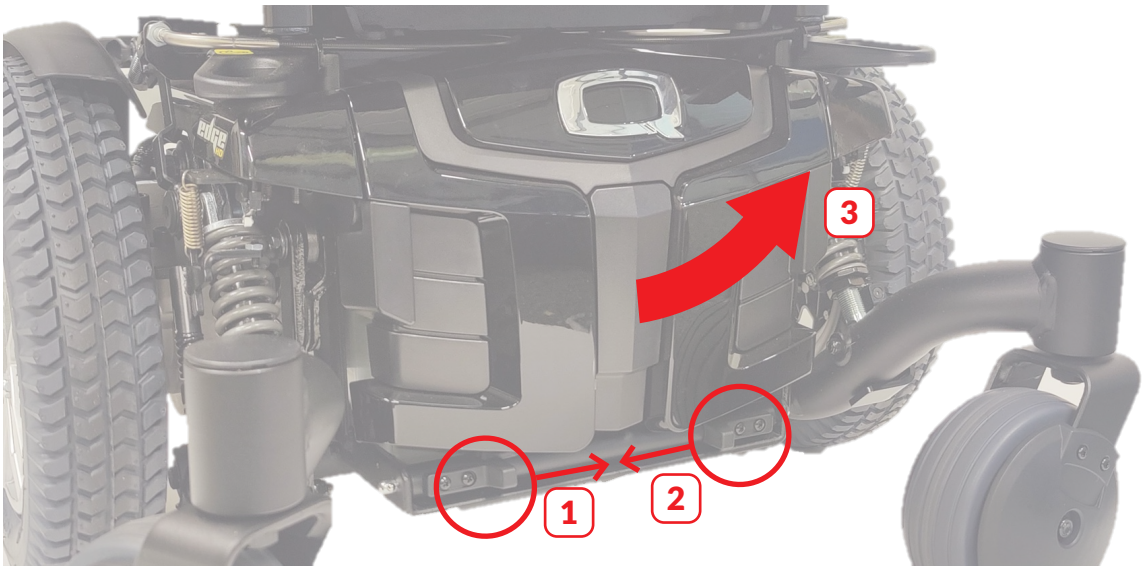
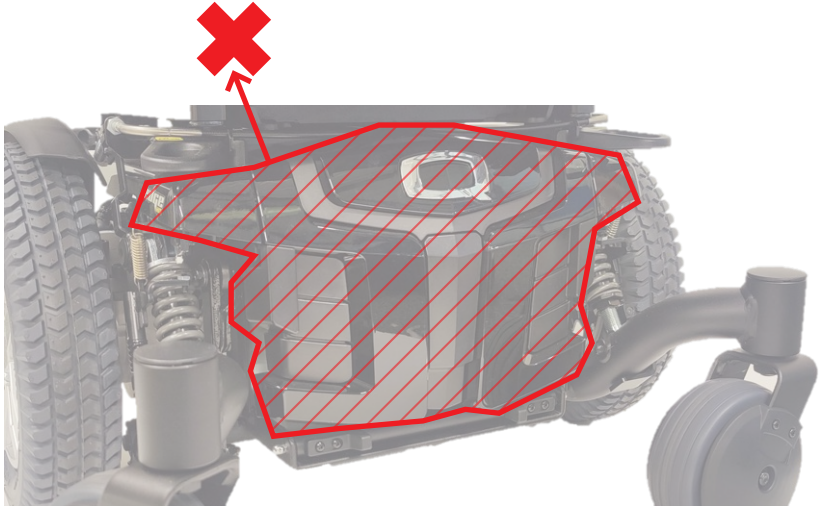

3

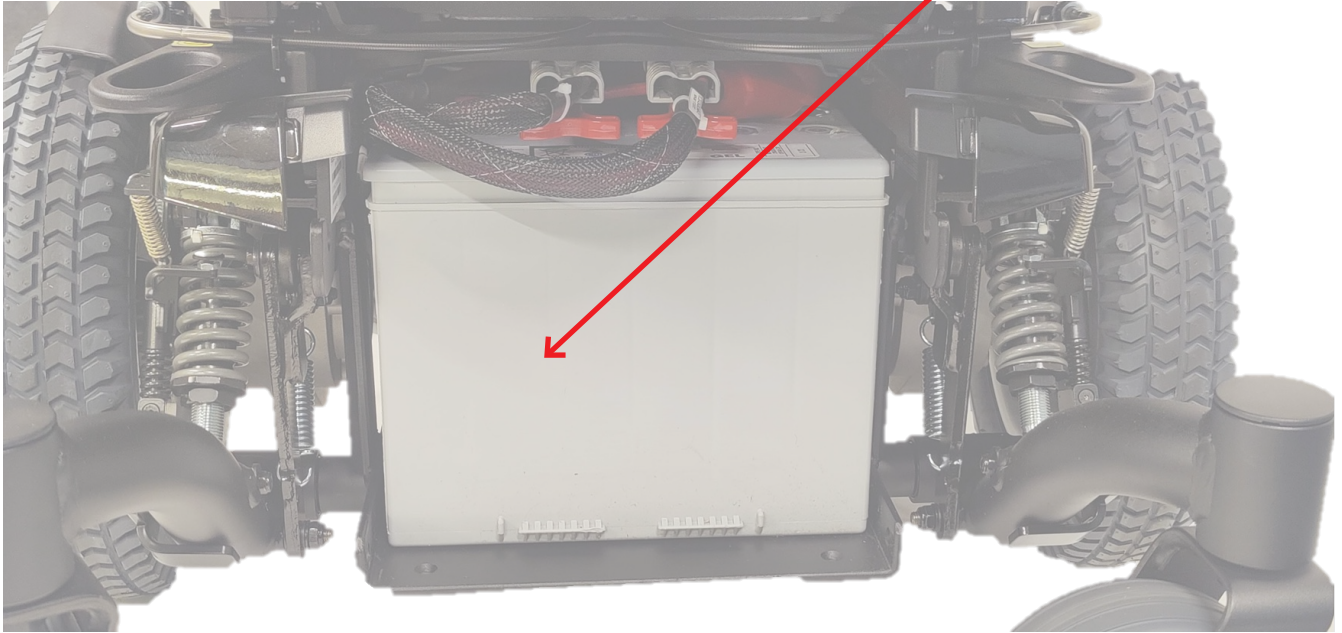
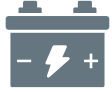

4

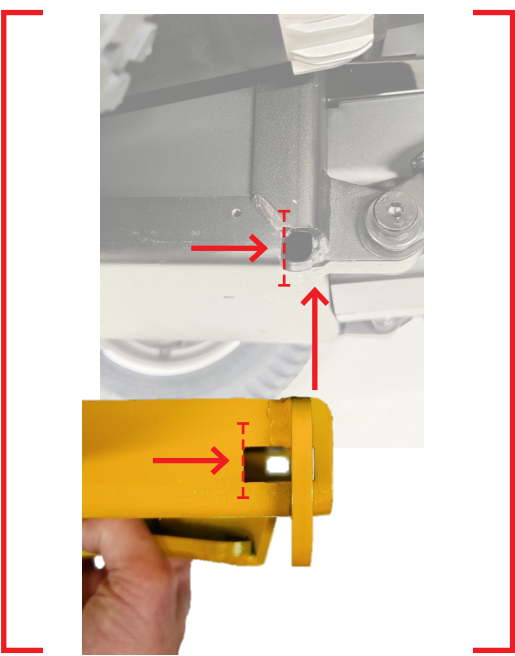
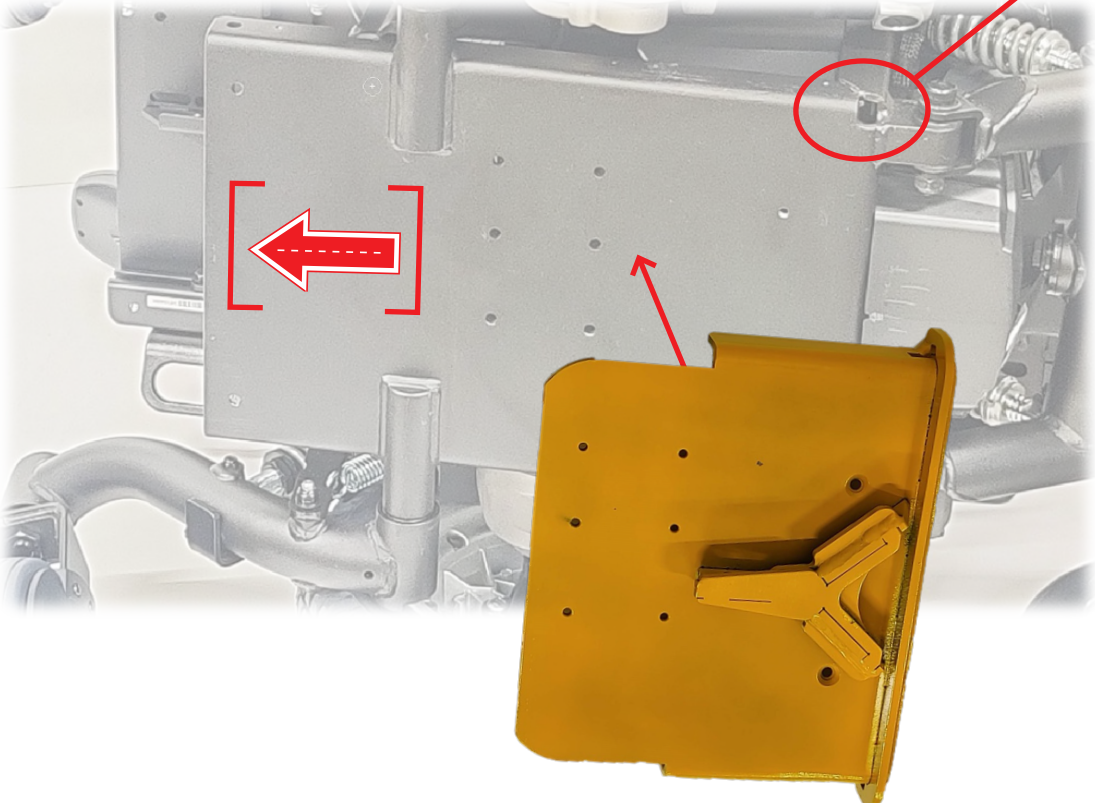
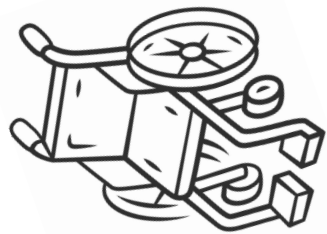
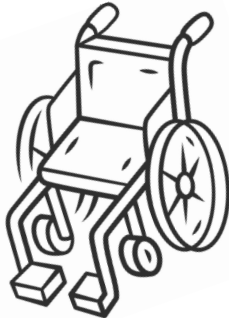

5

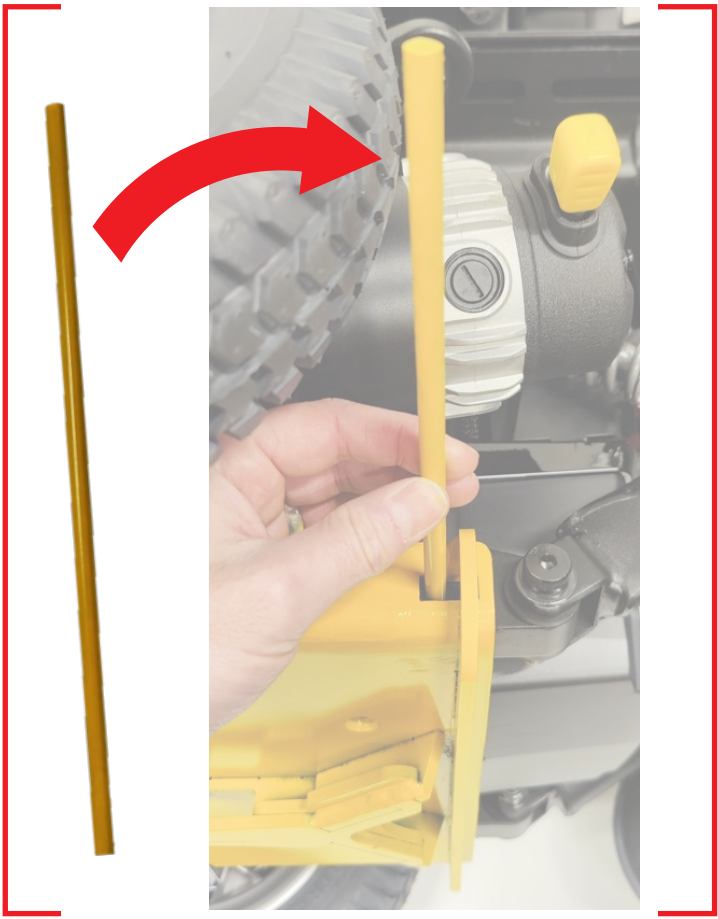
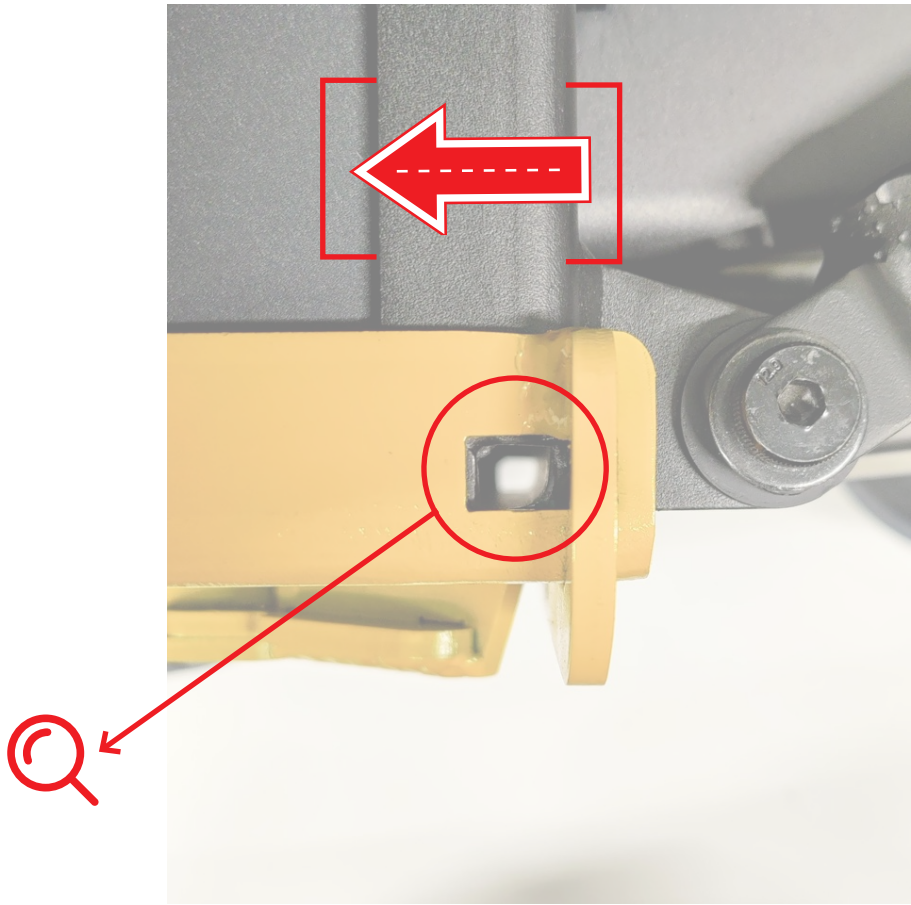

6

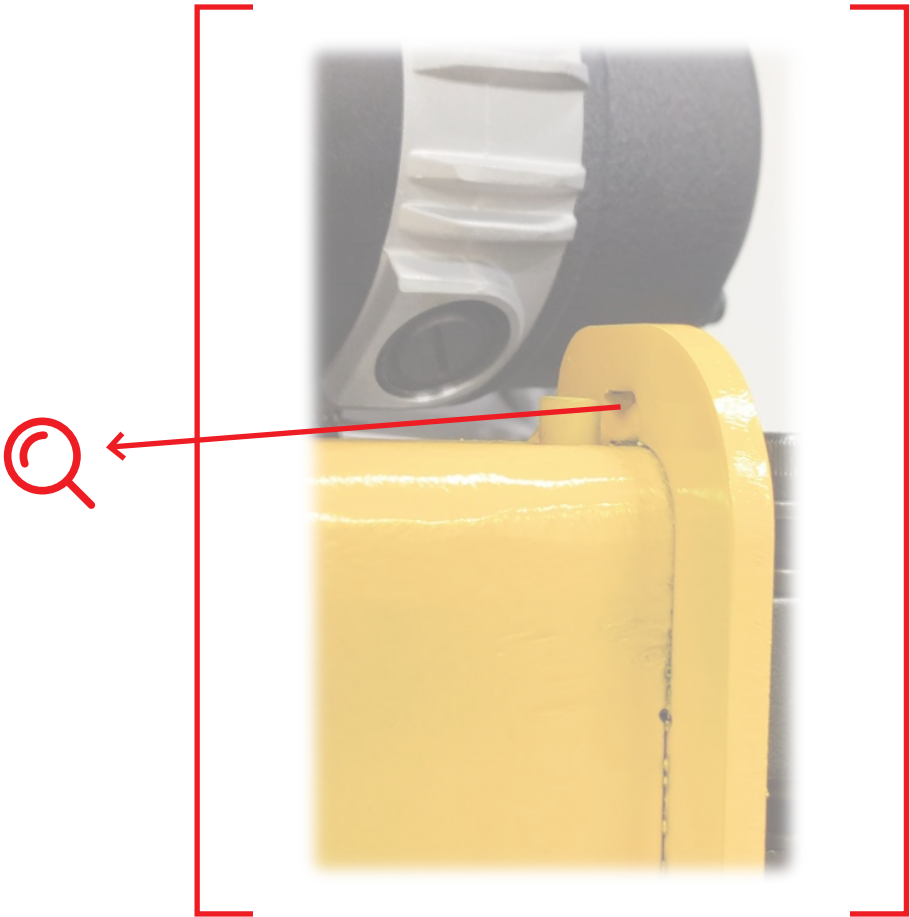
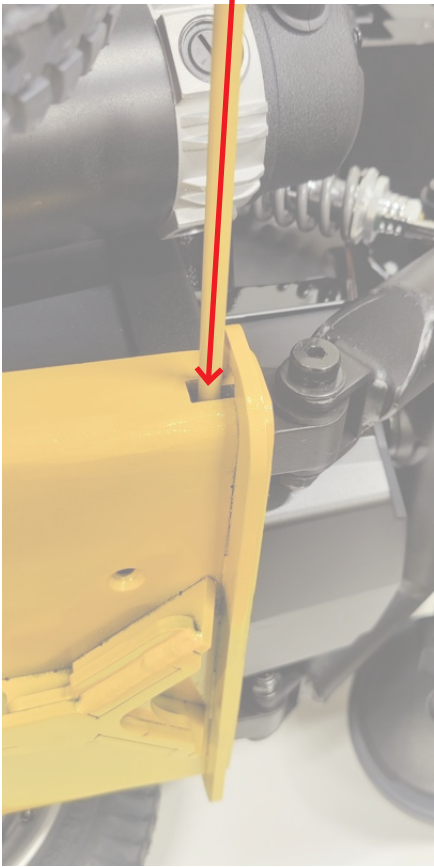

7

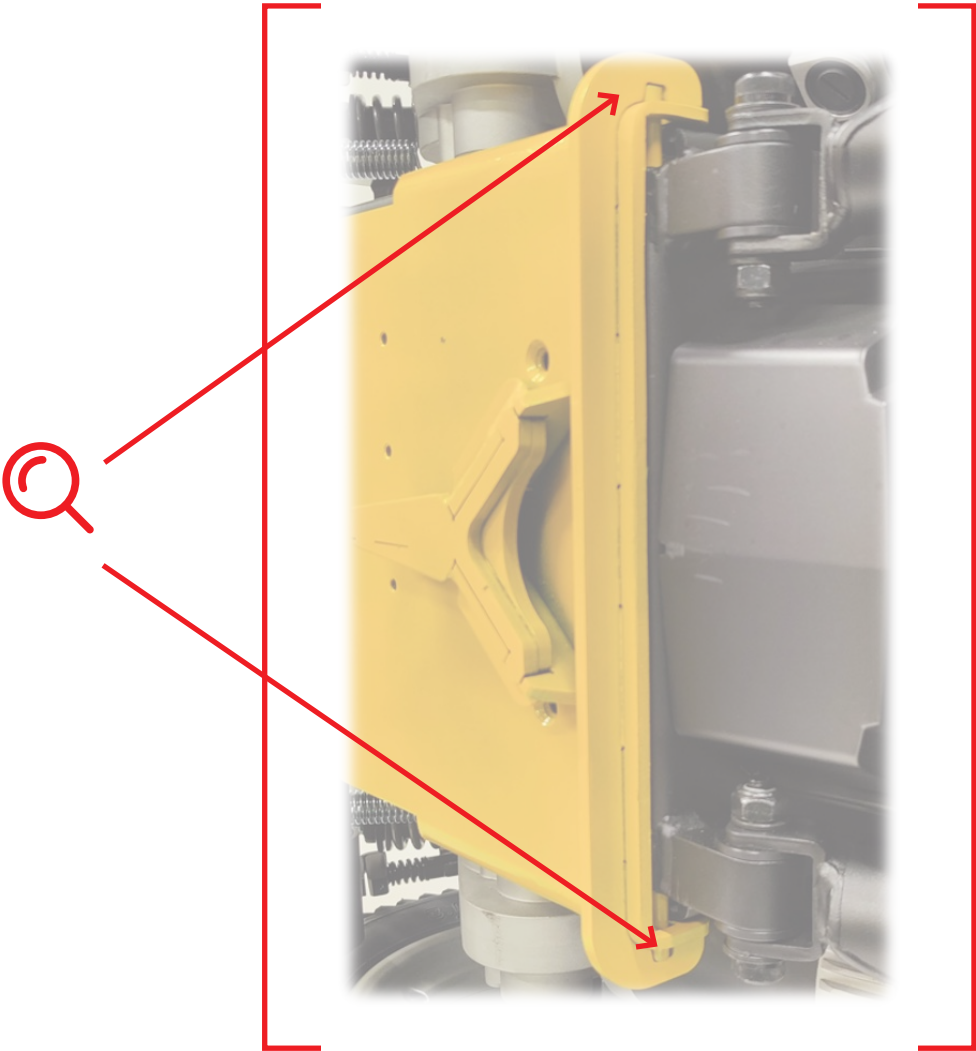
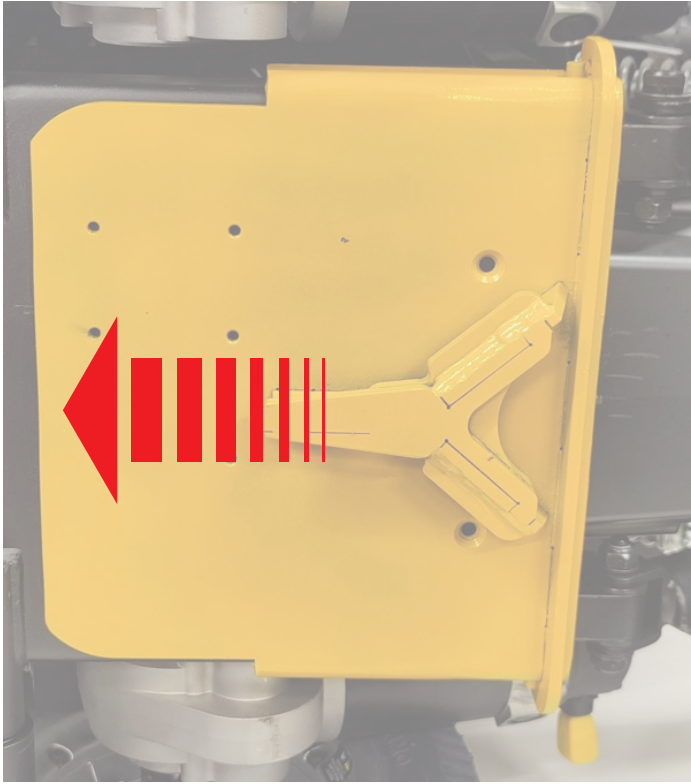

8

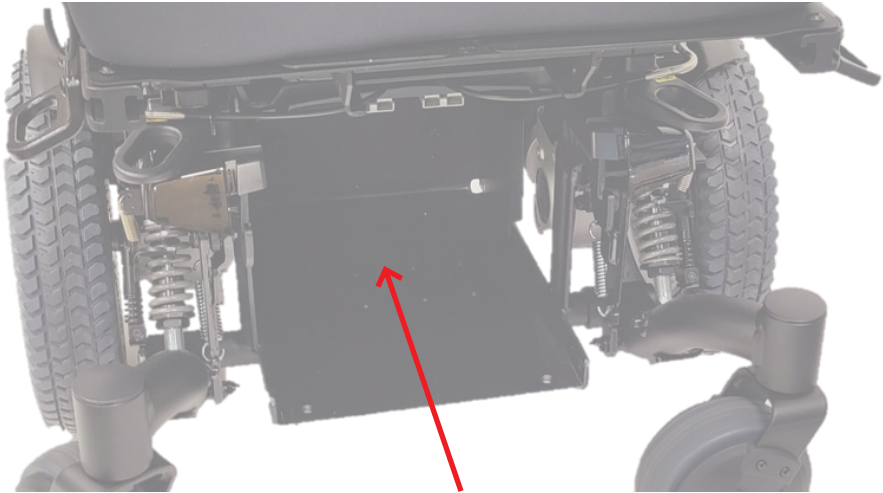

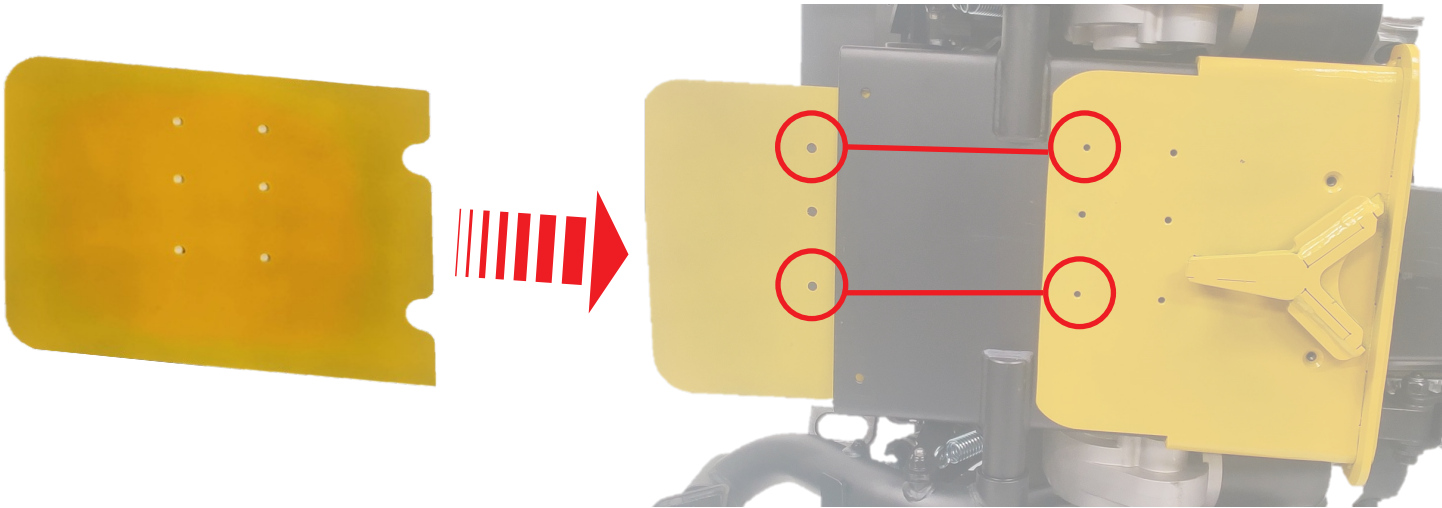

10



M6x16 x 6

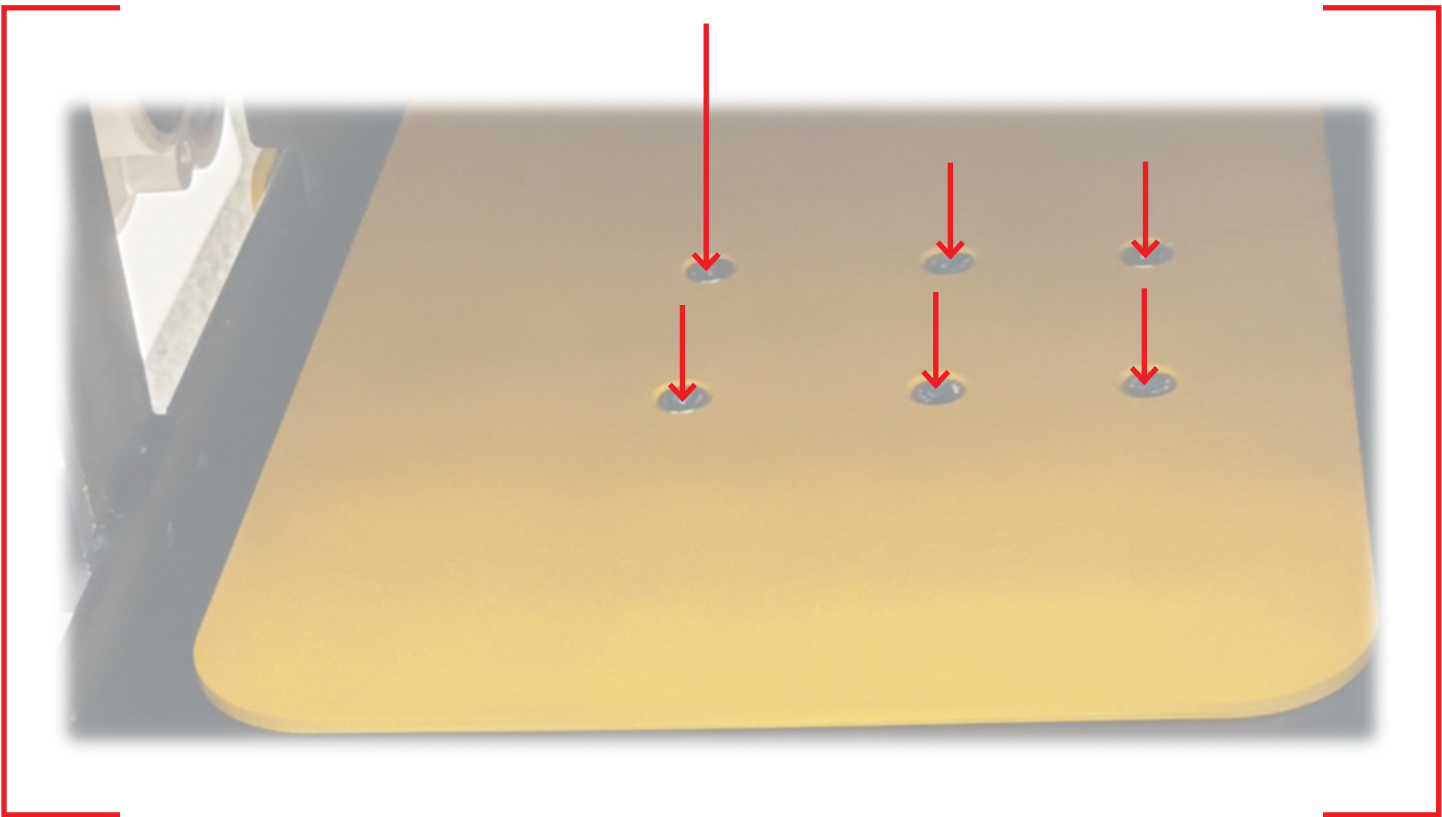
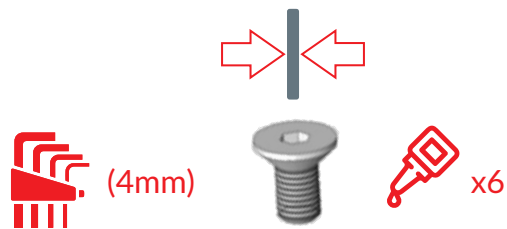
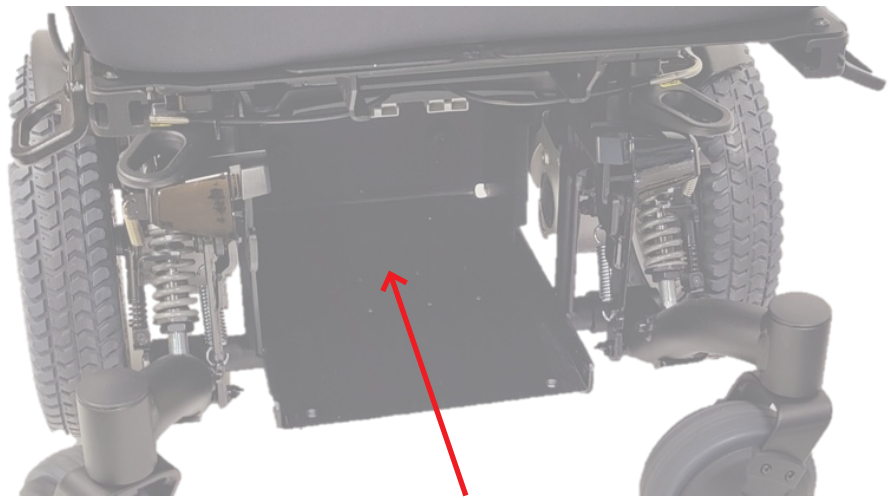

11



M6x16 x 2

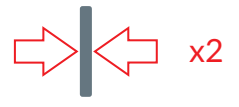
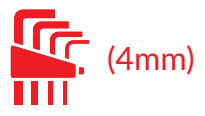
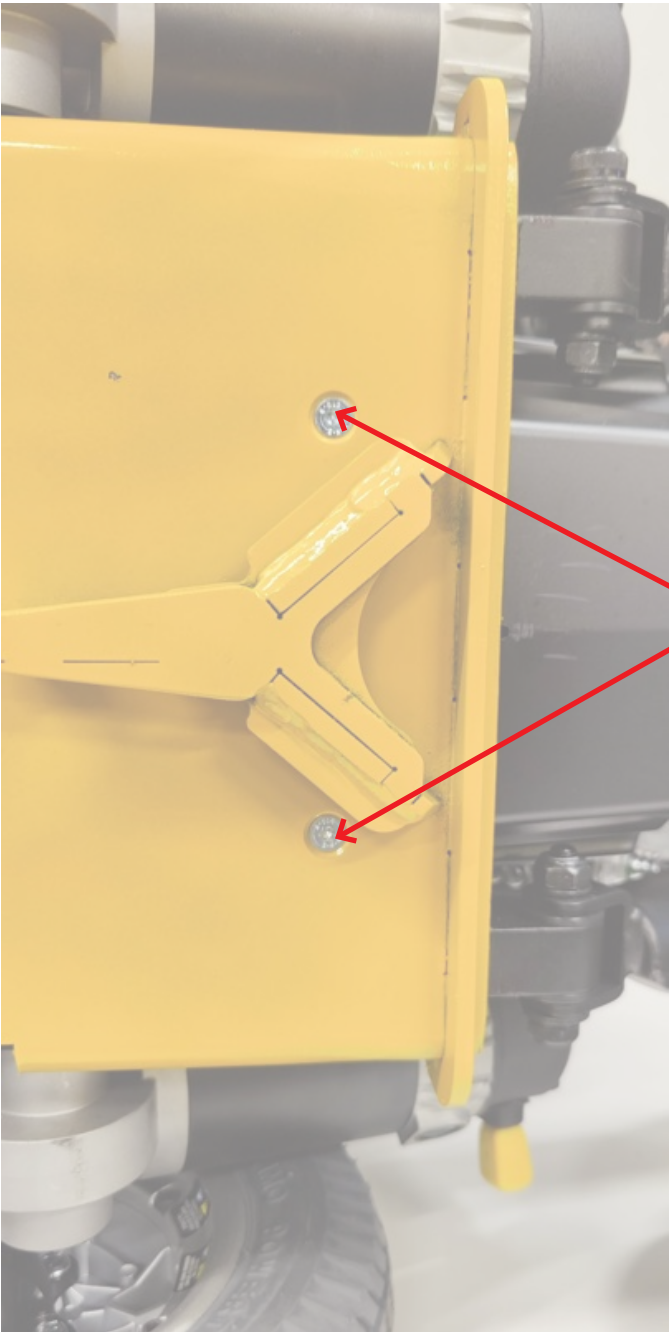

12

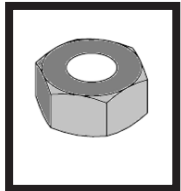

M6x16 x 2

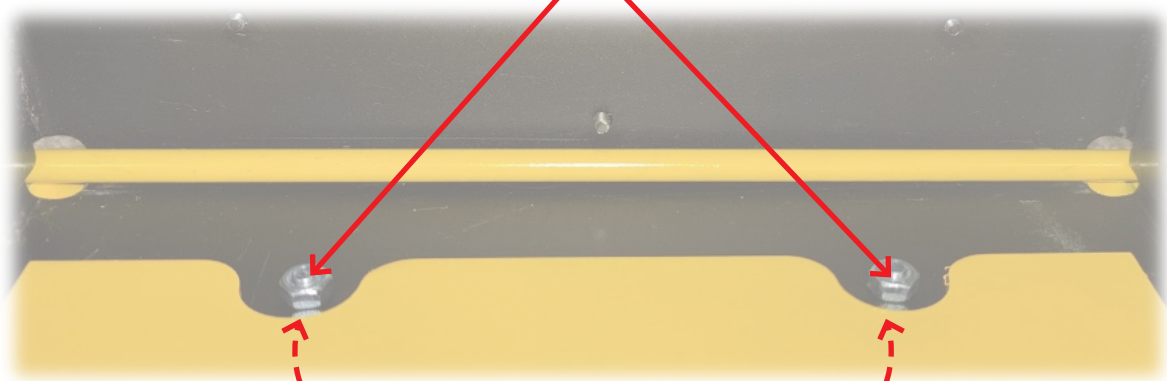
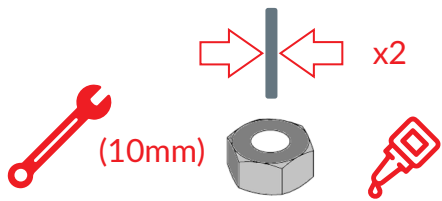
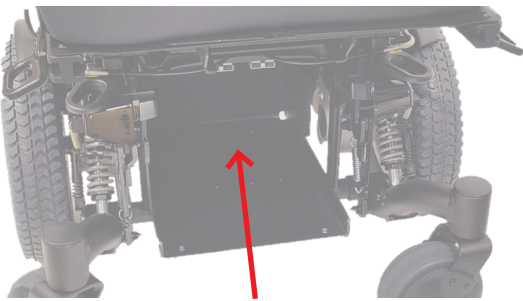

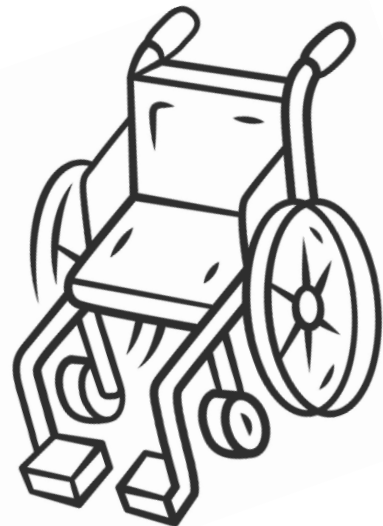
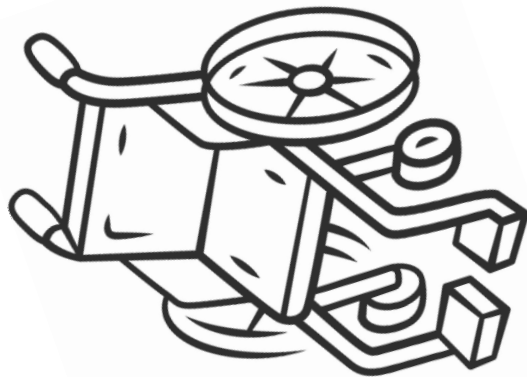

QLK ALIGNMENT

QLK Alignment QLK Alineación QLK Ausrichtung

1



2

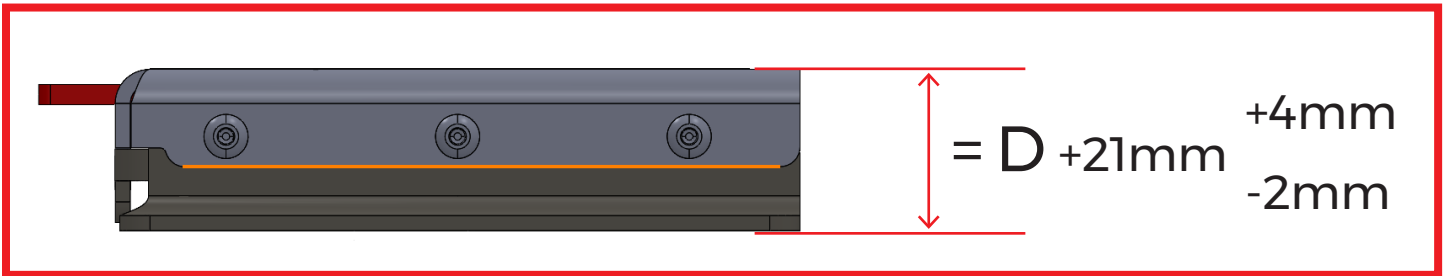
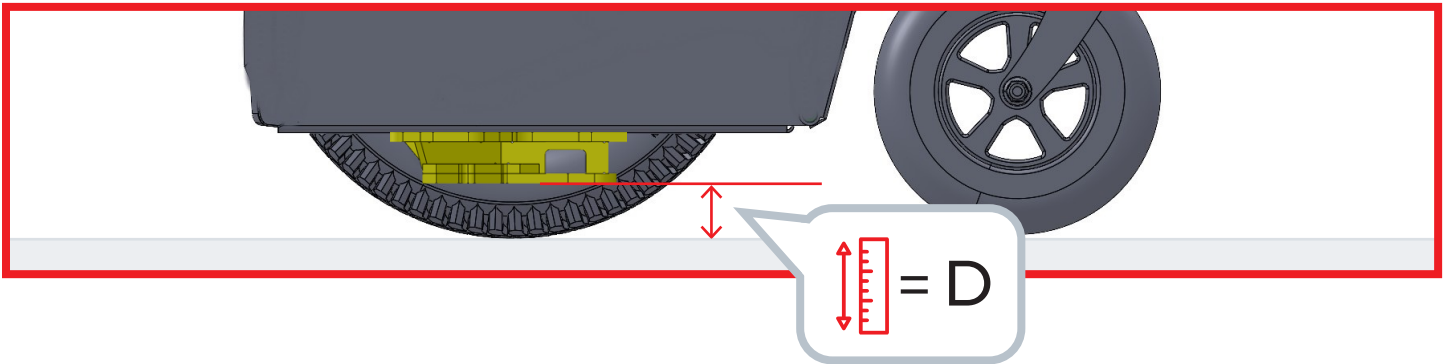

Q'STRAIT®

www.qstraint.com

© 2022 Q'STRAIT®. All Rights Reserved.

Q'STRAIT® and Q'STRAIT® logo are registered trademarks of Q'STRAIT®, Inc. QLK is a trademark of Q'STRAIT®, Inc. Products mentioned herein are for identification purposes only and may be registered trademarks, trademarks and patents of their respective companies. All other brand names, trademarks, registered trademarks and patents are the property of their respective owners.

These instructions contain the most current information at the time of printing. Q'STRAIT® reserves the right to modify systems, components and content without notice.

? FOR TECHNICAL SUPPORT OR TO FIND YOUR NEAREST AUTHORIZED DEALER:

Q'STRAIT EUROPE

72-76 John Wilson Business Park
Whitstable, Kent, CT5 3QT
United Kingdom
Tel: +44 (0)1227 773035
Fax: +44 (0)1227 770035
Email: info@qstraint.co.uk

Q'STRAIT AMERICA

4031 NE 12th Terrace
Oakland Park, FL 33334
Tel: 800-987-9987
Fax: 954-986-0021
Email: qstraint@qstraint.com

Q'STRAIT AUSTRALIA

Tramanco Pty Ltd.
21 Shoebury Street,
Rocklea, Australia, QLD. 4106
Tel: +61 7 3892 2311
Fax: +61 7 3892 1819
Email: info@tramanco.com.au