

# Q'STRAIN<sup>®</sup>

# QLK<sup>®</sup>

## QUANTUM R-TRAK

## MOUNTING BRACKET INSTALLATION INSTRUCTIONS

**STOP**

### READ ALL INSTRUCTIONS PRIOR TO INSTALLATION

- **Some foot rest options will require the user to raise prior to allow docking. Any kerb climbers fitted to the chair may interfere with the docking process – please ensure at least 85mm ground clearance.**
- This is a comprehensive step-by-step instruction guide on how to install the Quantum R-Trak Wheelchair Bracket (Q3 2024; Wheelchair manufacture date).
- Please note, some images may not be the same colour as the supplied equipment.
- Make sure to read, understand and follow these instructions.
- To address any questions, contact the nearest Q'STRAIN<sup>®</sup> office.
- All deviations and alterations from these instructions **MUST** be reported to both your supervisor and Q'STRAIN<sup>®</sup>
- For installation of the QLK Docking system, please refer to the separate Installation Instructions and the Use and Care Manual.



### IMPORTANT SAFEGUARDS AND WARNINGS

- All equipment and components **MUST** be installed and serviced by an experienced and trained technician.
- The QLK Wheelchair Docking System complies with all applicable requirements of ADA, FMVSS, CMVSS, SAE J2249, CSA Z604, AS2942, ISO 10542-1 and ANSI/RESNA WC-4 SECTION 18.
- This System is a complete integrated system, do not alter or modify it in any way and do not interchange or substitute any components. Any deviation from these recommendations is the responsibility of the installer.
- The QLK Docking System, bracket and its components **MUST** be regularly inspected, cleaned, and maintained.
- Do **NOT** attempt to repair, adjust, or modify any component(s) of the QLK system or bracket without consulting a Q'STRAIN<sup>®</sup> representative.
- The QLK Wheelchair Docking System should not be operated by anyone who does not have full comprehension of how the System works or if the System is not working properly.
- The QLK Wheelchair Docking System, bracket and all system components including floor and wall anchorages **MUST** be replaced after a vehicle collision.
- The QLK Wheelchair Docking System **MUST** be installed with a compliant occupant restraint system (shoulder and lap belt).
- Broken and worn components **MUST** be replaced.
- All damages and defects **MUST** be reported to both your supervisor and Q'STRAIN<sup>®</sup>.
- Only use Q'STRAIN<sup>®</sup> components with this system, including hardware and wheelchair interface bracket unless otherwise stated.
- Q'STRAIN wheelchair brackets and QLK docking station have been designed and tested as a system, for use with specific wheelchairs. Q'STRAIN supply all the components/hardware required to install the system so the configuration is the same as that tested and set out in the individual installation instructions. Occasionally, wheelchairs may have additional components installed which are not detailed in our installation instructions and which may need to be temporarily removed in order to gain access to fixing holes or support frames to enable the attachment of the wheelchair bracket. It is the responsibility of the installer to ensure that all such wheelchair component(s) are put back in their original location using the original fixings or fixing of the same size and grade. Each wheelchair should be test driven after fitment of the bracket, to ensure it is functioning correctly.

**SAVE THESE INSTRUCTIONS**



	<b>Go To Sequence Number</b> Ir a Número de secuencia	<b>Aller à Numéro de séquence</b> <b>Gehe zu</b> Sequenznummer
	<b>Repeat Sequence(s) in defined order</b> Repita la secuencia en un orden definido	<b>Répéter la séquence</b> dans l'ordre défini <b>Sequenz in definierter Reihenfolge</b> wiederholen
	<b>Step Number</b> Número de paso	<b>Numéro d'étape</b> <b>Schrittnummer</b>
	<b>Rotate/Turn (angle)</b> Rotar/Girar (ángulo)	<b>Tourner/Tourner (angle)</b> <b>Drehen/Drehen (Winkel)</b>
	<b>Move circled object</b> Mover objeto dentro de un círculo	<b>Déplacer objet encerclé</b> <b>Bewegen eingekreistes Objekt</b>
	<b>Remove/Detach highlighted object</b> Quitar/Separar objeto resaltado	<b>Supprimer/Détacher l'objet en surbrillance</b> Markiertes Objekt <b>entfernen/lösen</b>
	<b>Move to Remove or Replace</b> Mover para Quitar o Reemplazar	<b>Déplacer pour supprimer ou remplacer</b> <b>Wechseln Sie zu Entfernen oder Ersetzen</b>
	<b>Repeat (sequence) on opposite side</b> Repetir (secuencia) en el lado opuesto	<b>Répéter (séquence) du côté opposé</b> <b>Wiederholen Sie (Sequenz) auf der gegenüberliegenden Seite</b>
	<b>Inspect</b> Inspeccionar	<b>Inspecter</b> <b>Prüfen</b>
	<b>Disconnect Battery</b> Desconecte la batería	<b>Déconnecter la batterie</b> <b>Batterie abklemmen</b>
	<b>Reconnect Battery</b> Vuelva a conectar la batería	<b>Reconnecter la batterie</b> <b>Batterie wieder anschließen</b>
	<b>Remove Battery</b> Retire la batería	<b>Retirer la batterie</b> <b>Batterie entfernen</b>
	<b>Replace Battery</b> Reemplazar la batería	<b>Remplacer la batterie</b> <b>Batterie wechseln</b>
	<b>Allen Key (size)</b> Llave Allen (tamaño)	<b>Clé Allen (taille)</b> <b>Inbusschlüssel (Größe)</b>
	<b>Spanner/Socket (size)</b> Llave/Tubo (tamaño)	<b>Clé/douille (taille)</b> <b>Schraubenschlüssel/Stecknuss (Größe)</b>



	<b>Disconnect</b> Desconectar	Déconnecter Trennen
	<b>Optional Step</b> Paso opcional	Étape facultative Optionaler Schritt
	<b>Medium Strength Threadlock</b> Threadlock de fuerza media	Threadlock de puissance moyenne Threadlock mittlerer Stärke
	<b>Tighten</b> Apretar	Serrer Spannen
	<b>Do Not Tighten</b> No apriete	Ne pas serrer Nicht festziehen
	<b>Measure</b> Medida	Mesure Messen
	<b>Refer to OEM Manual</b> Consulte el Manual del OEM	Reportez-vous au manuel OEM Siehe OEM-Handbuch
	<b>Caution!</b> ¡Precaución!	Mise en garde! Vorsicht!
	<b>Cut</b> Corte	Couper Schnitt
	<b>Cable Tie</b> Brida	Attache de câble Kabelbinder
	<b>Points Toward Front of Chair</b> Apunta hacia el frente de la silla	Points vers l'avant de la chaise Zeigt zur Vorderseite des Stuhls
	<b>Shown for Reference</b> Mostrado como referencia	Montré pour référence Als Referenz gezeigt
	<b>Twist</b> Giro	Torsion Twist



		
<b>QS01285</b>		1
<b>QS01380</b>		1
<b>QS01381</b>		1
<b>Q03C0085</b> 2mm		2
<b>QE9-5101</b> M8x25		6
<b>QE9-8161</b> M8x30		3
<b>QE9-8108</b> M8		3
<b>QE9-8109</b> M8		3
<b>Q04S151</b>		1
<b>QC03005</b>		1

Q080081

Q03BR159

Q04F0148

QE-9317

# INSTALLATION PROCEDURE

Procédure d'installation    Procedimiento de instalación    Installationsvorgang

1

**Some images used in the following procedure may not be a true representation of actual chair**

Certaines images utilisées dans la procédure suivante peuvent ne pas être une représentation fidèle de la chaise réelle

Algunas imágenes utilizadas en el siguiente procedimiento pueden no ser una representación fiel de la silla real

Einige Bilder, die im folgenden Verfahren verwendet werden, sind möglicherweise keine wirkliche Darstellung des tatsächlichen Stuhls

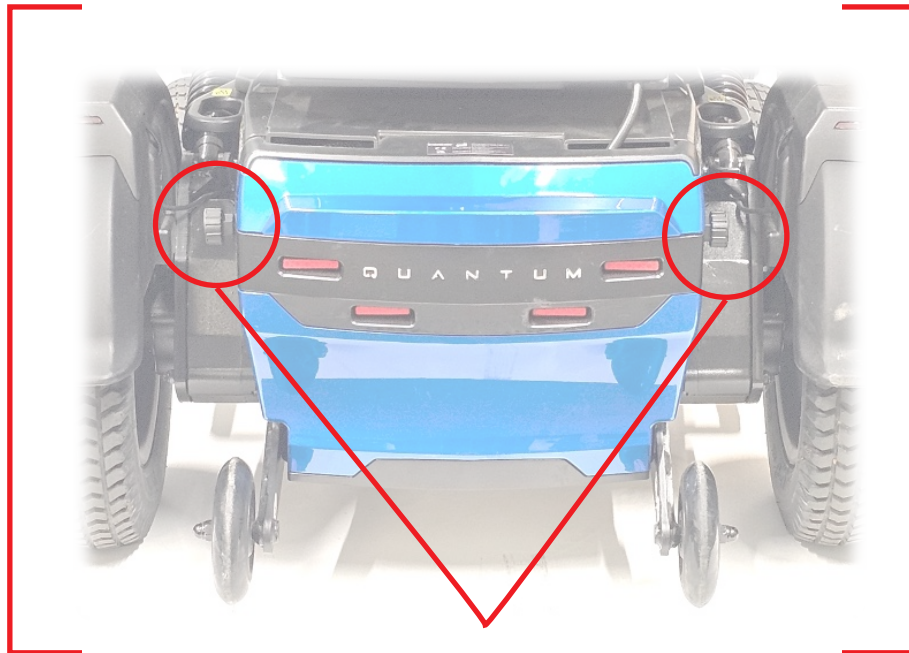

2

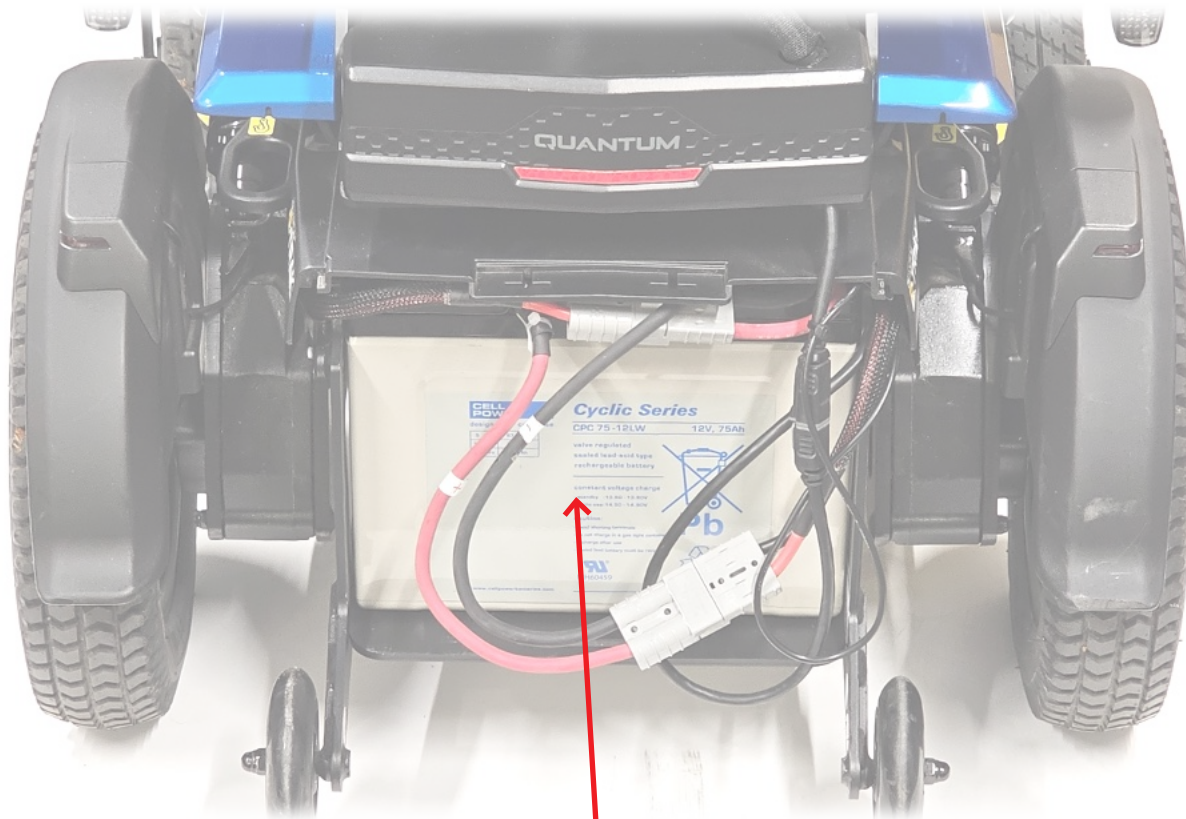

3

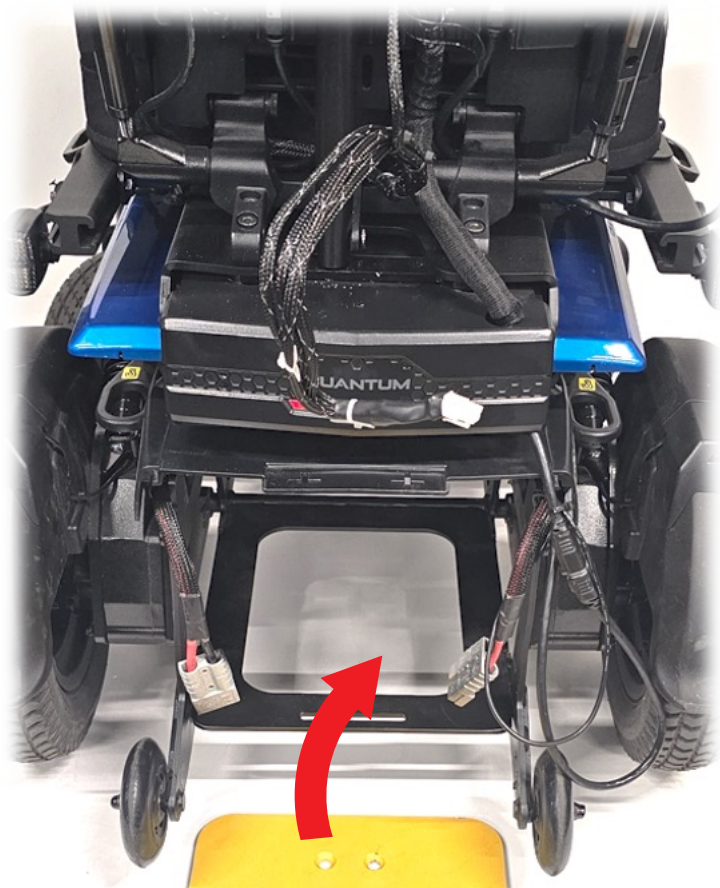

(QS01380)

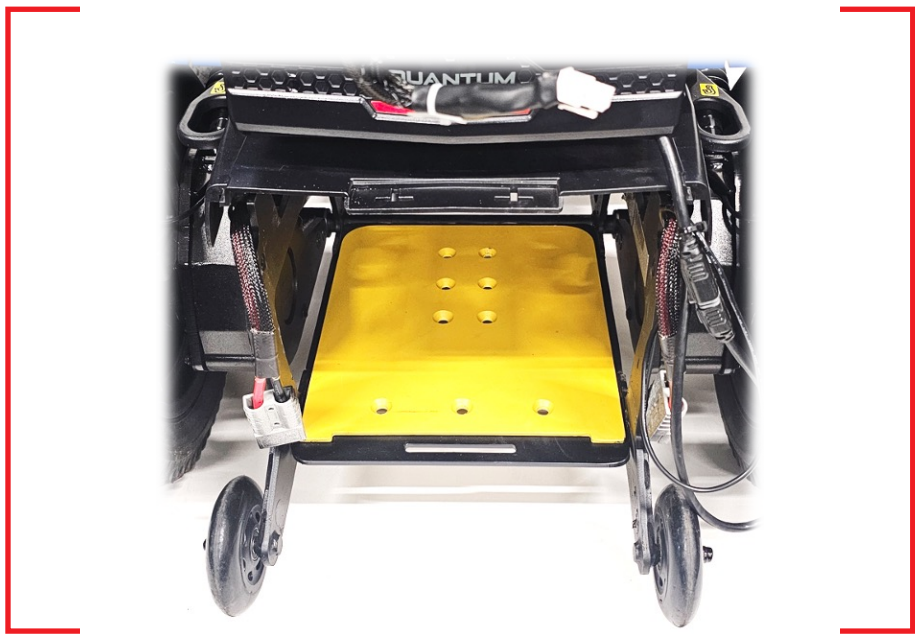
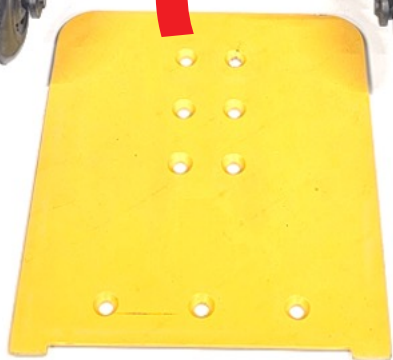

3 x (M8x30mm)

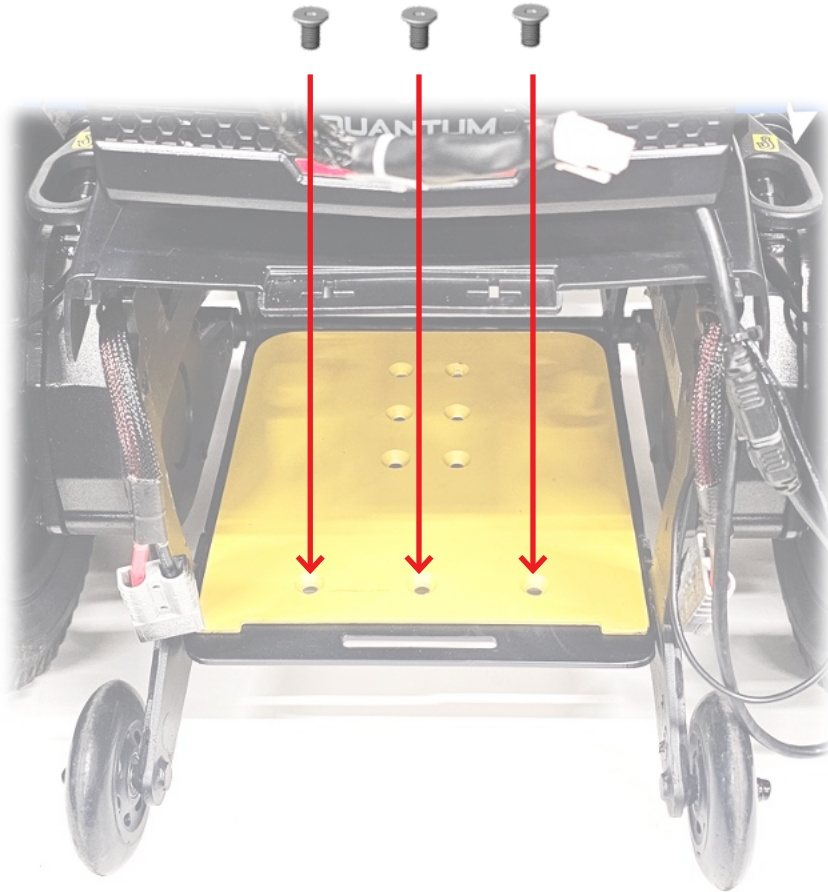

5

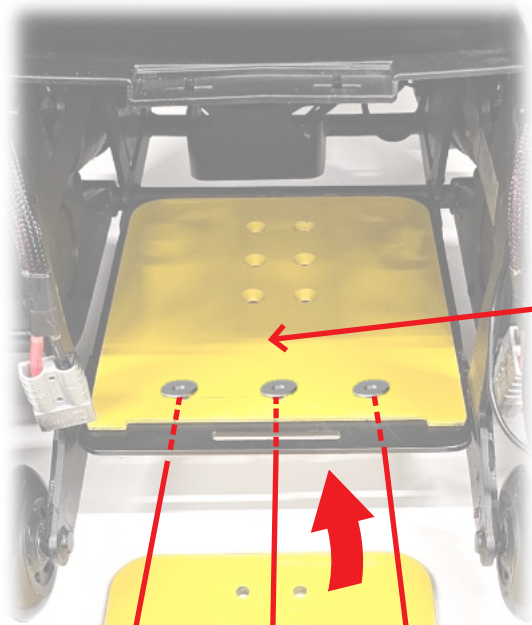

  
(5mm)

(QS01381)

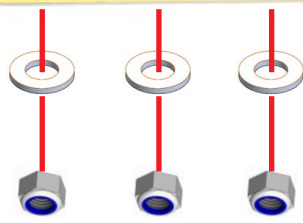

  
(13mm)

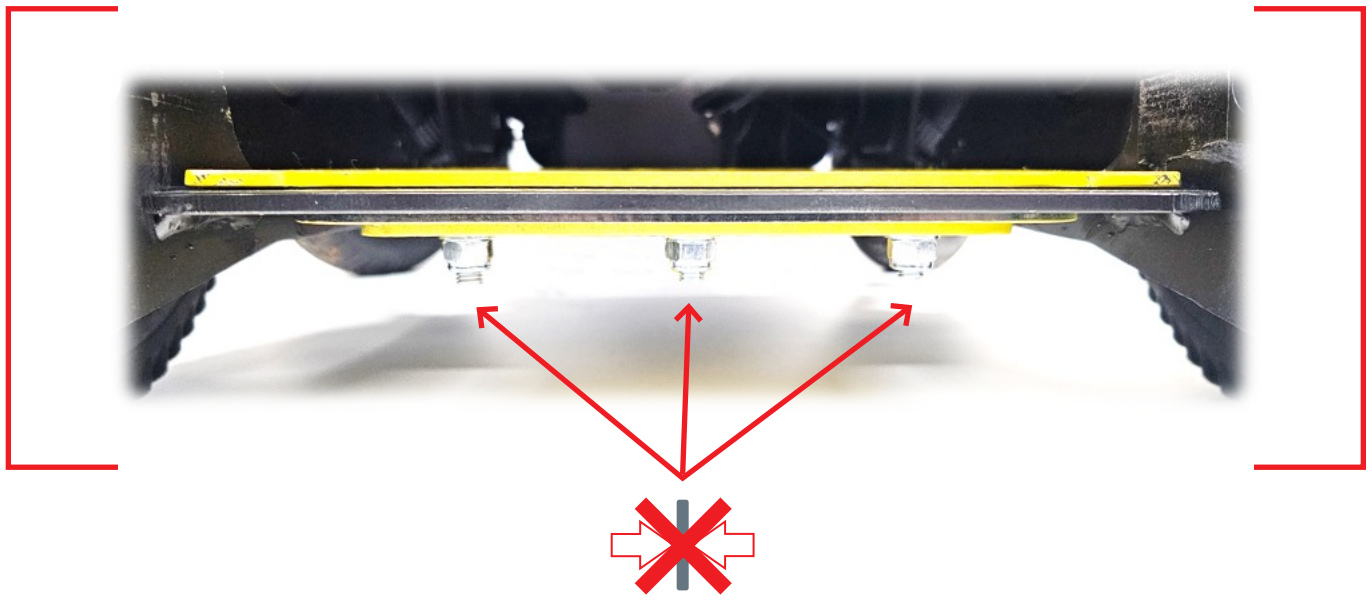

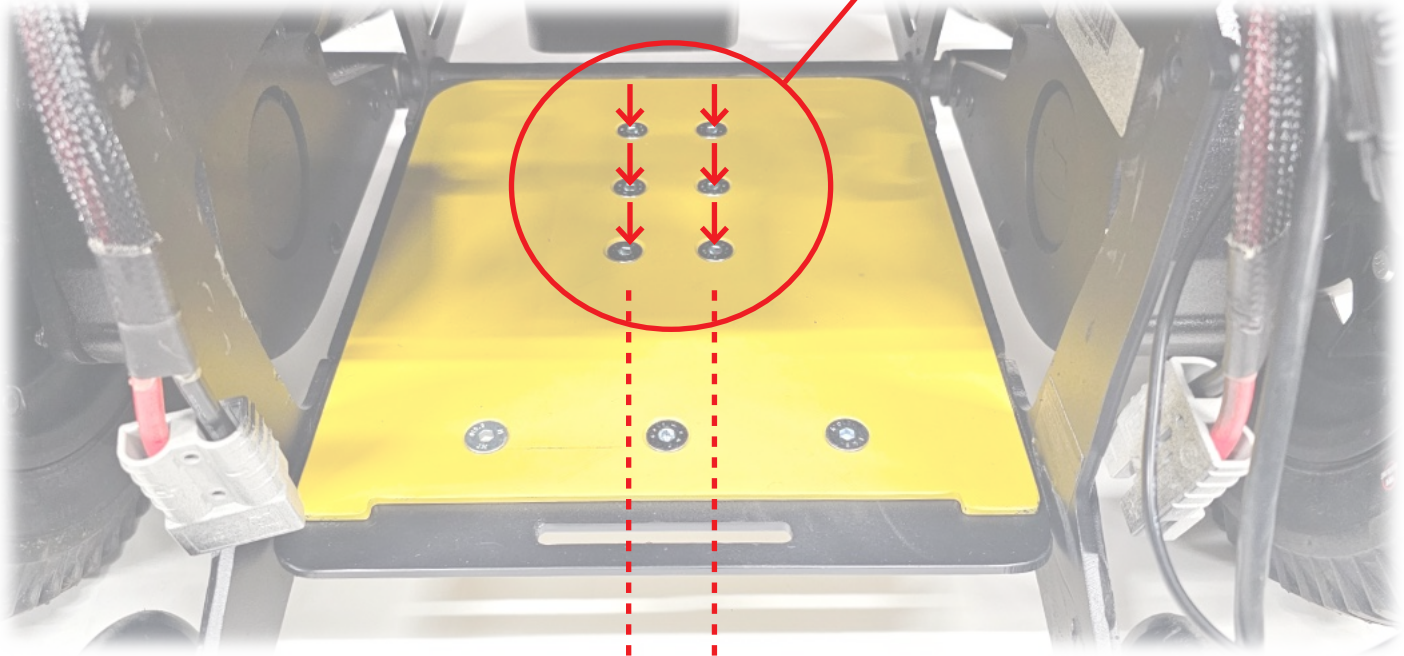
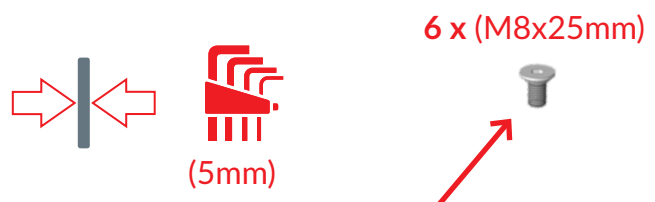

(QS01285)

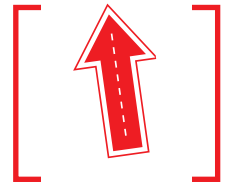
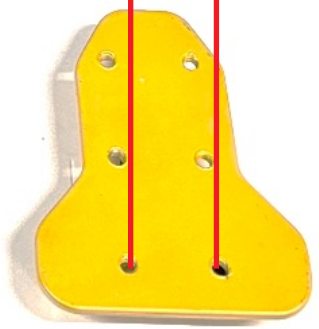

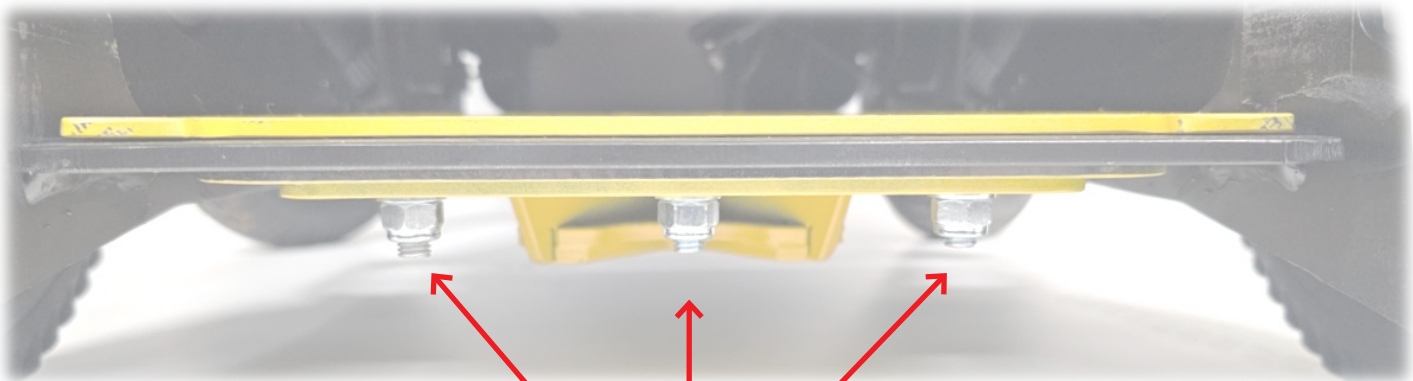
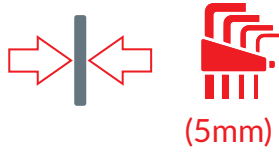

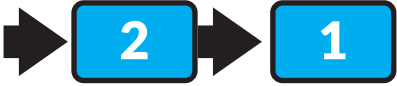
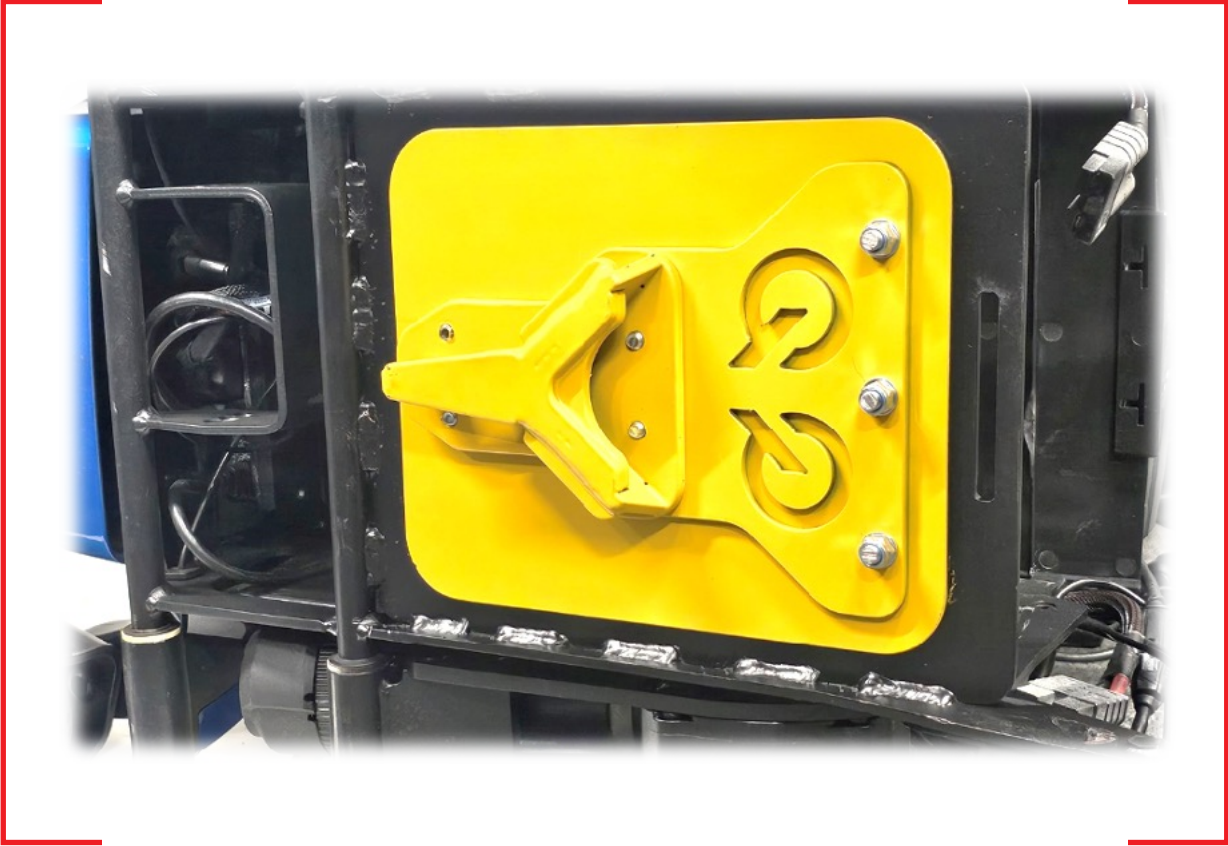

# QLK ALIGNMENT

QLK Alignment QLK Alineación QLK Ausrichtung

1



2

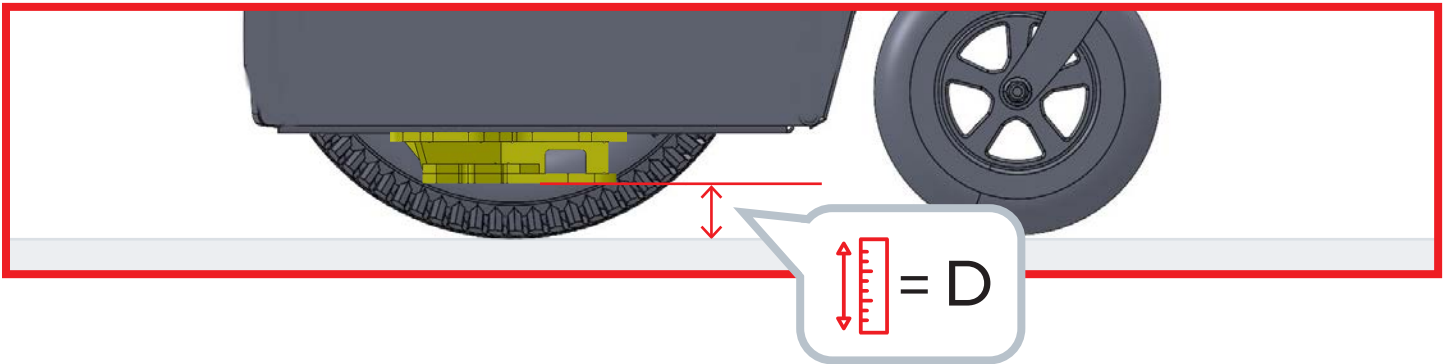

# Q'STRAIT®

[www.qstraint.com](http://www.qstraint.com)

© 2022 Q'STRAIT®. All Rights Reserved.

Q'STRAIT® and Q'STRAIT® logo are registered trademarks of Q'STRAIT®, Inc. QLK is a trademark of Q'STRAIT®, Inc. Products mentioned herein are for identification purposes only and may be registered trademarks, trademarks and patents of their respective companies. All other brand names, trademarks, registered trademarks and patents are the property of their respective owners.

These instructions contain the most current information at the time of printing. Q'STRAIT® reserves the right to modify systems, components and content without notice.

**? FOR TECHNICAL SUPPORT OR TO FIND YOUR NEAREST AUTHORIZED DEALER:**

#### Q'STRAIT EUROPE

72-76 John Wilson Business Park  
Whitstable, Kent, CT5 3QT  
United Kingdom  
Tel: +44 (0)1227 773035  
Fax: +44 (0)1227 770035  
Email: [info@qstraint.co.uk](mailto:info@qstraint.co.uk)

#### Q'STRAIT AMERICA

4031 NE 12th Terrace  
Oakland Park, FL 33334  
Tel: 800-987-9987  
Fax: 954-986-0021  
Email: [qstraint@qstraint.com](mailto:qstraint@qstraint.com)

#### Q'STRAIT AUSTRALIA

Tramanco Pty Ltd.  
21 Shoebury Street,  
Rocklea, Australia, QLD. 4106  
Tel: +61 7 3892 2311  
Fax: +61 7 3892 1819  
Email: [info@tramanco.com.au](mailto:info@tramanco.com.au)